

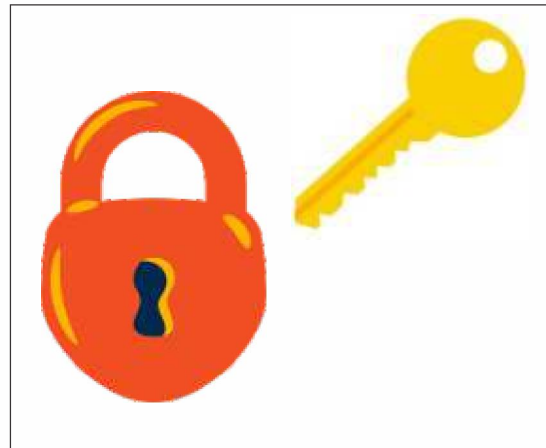

Student Name: _____ Date: _____

Circle the objects which are heavy:

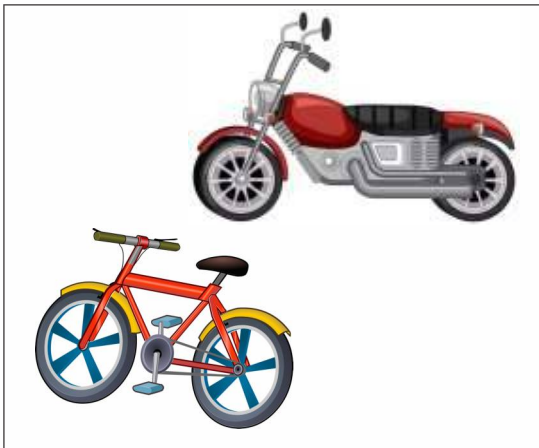

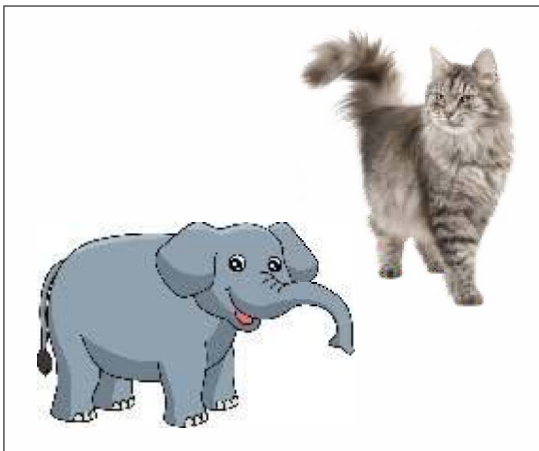
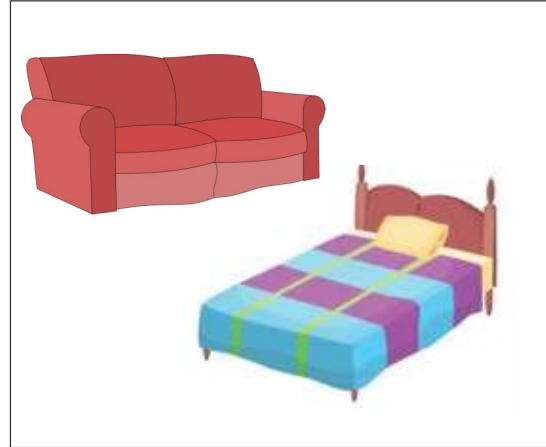
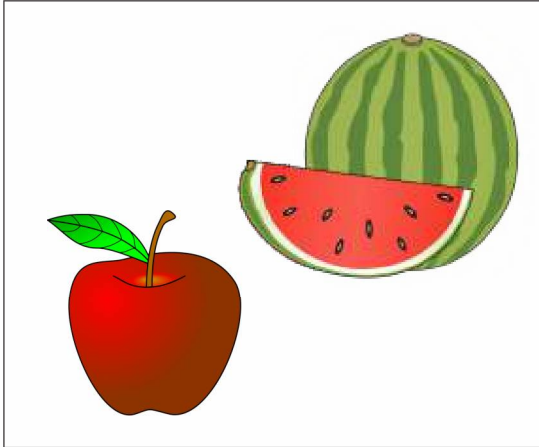

Student Name: _____ Date: _____

Colour the heavy vehicles:

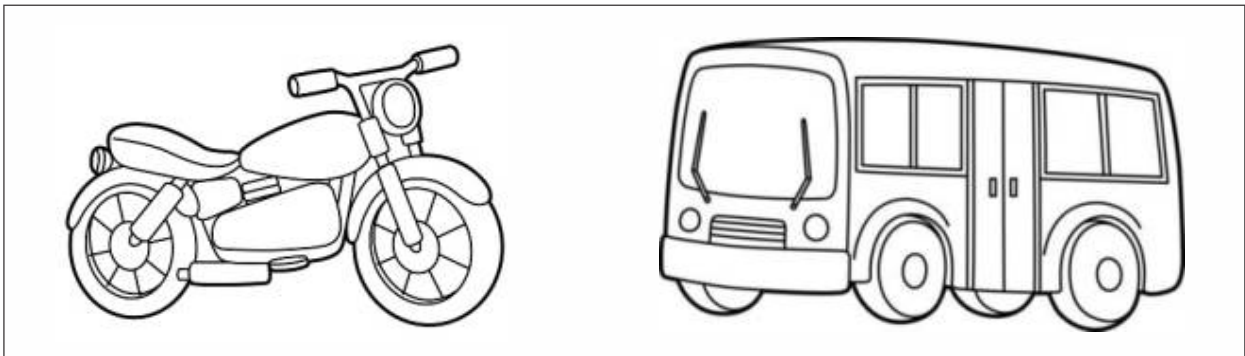
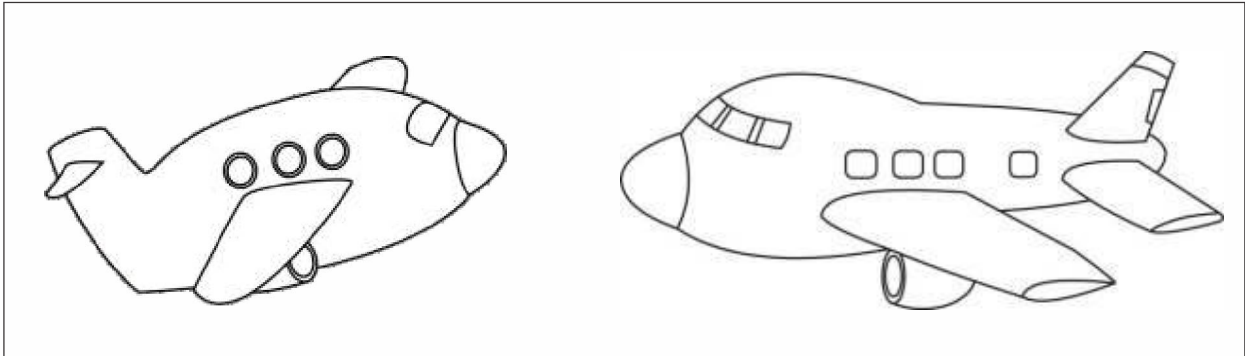
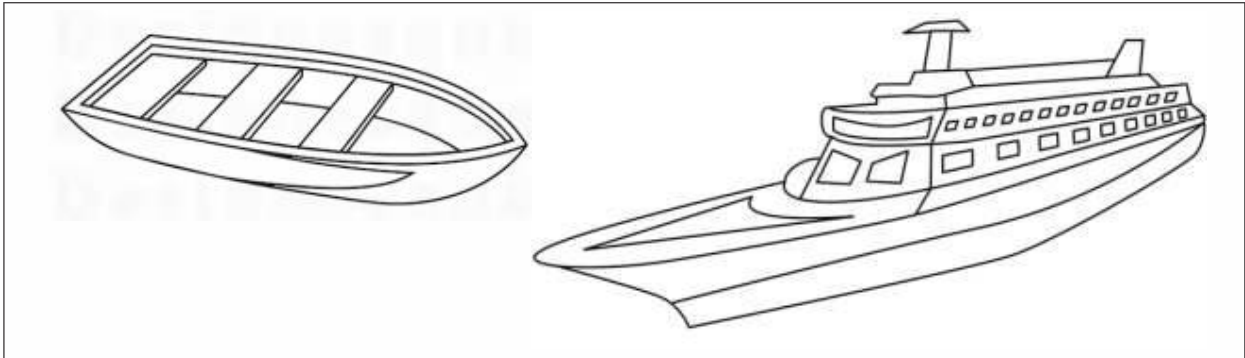
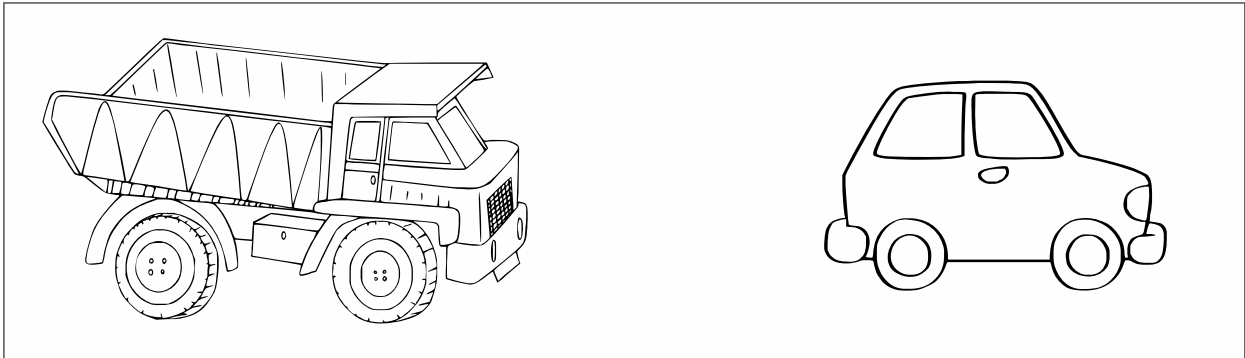



Student Name: _____ Date: _____

Which object is light tick (✓) it:

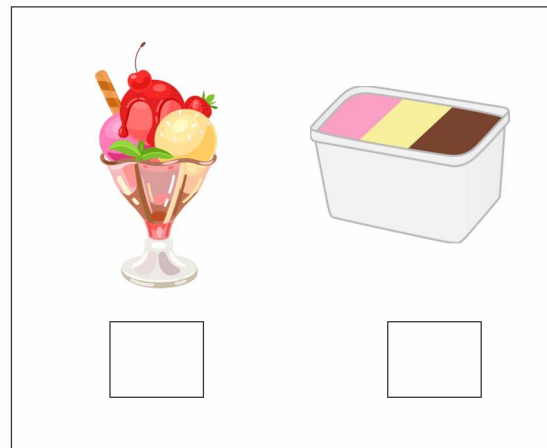
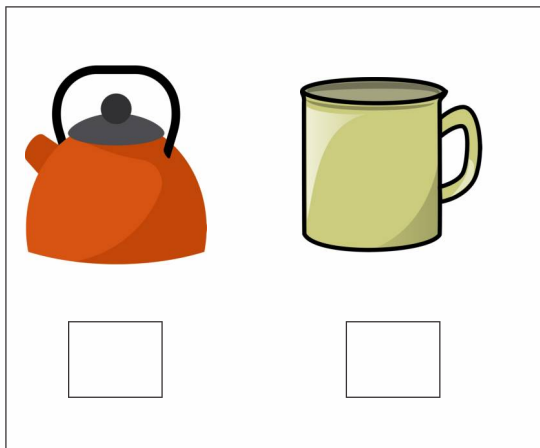
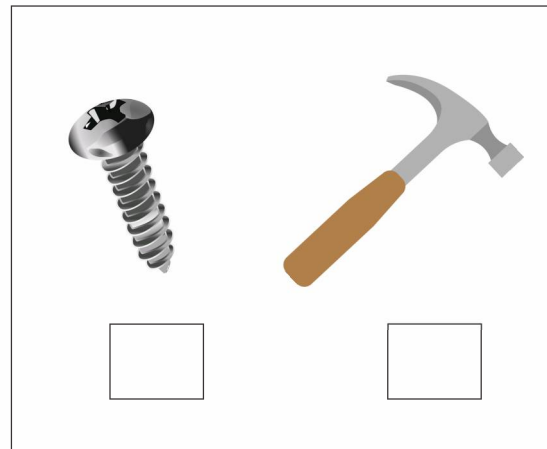
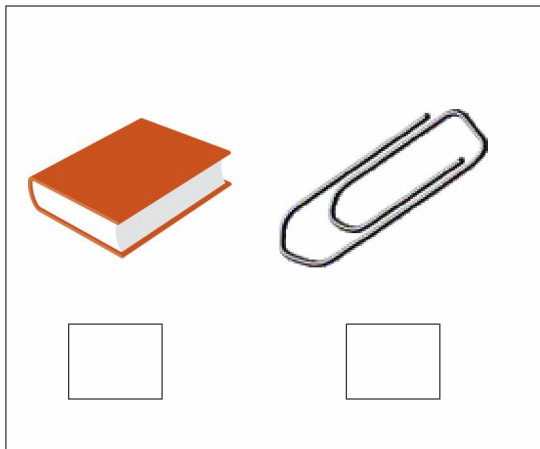
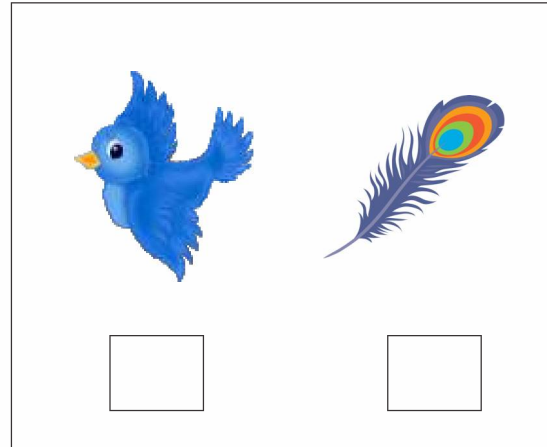
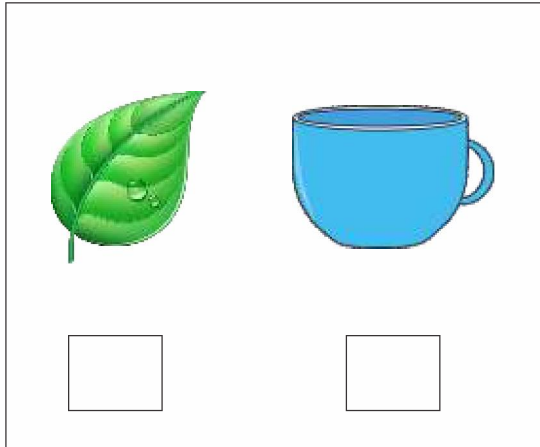



Student Name: _____ Date: _____

Colour the light objects:

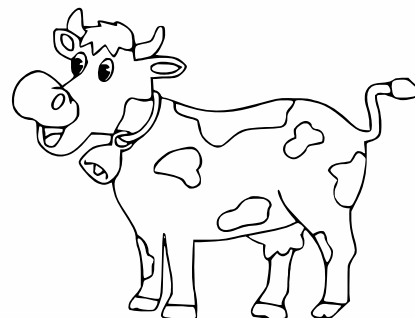
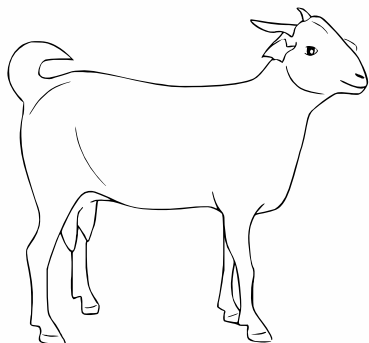
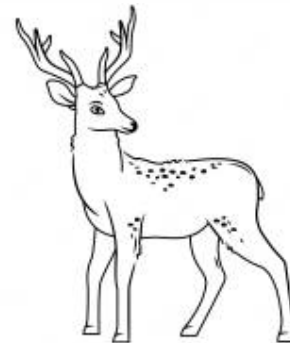
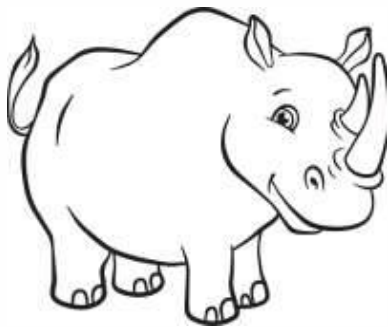
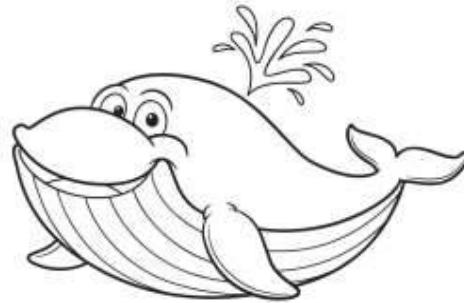
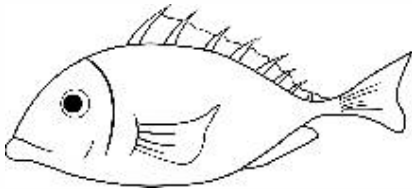
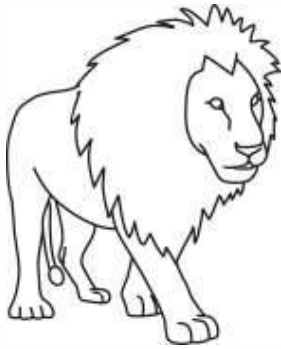



Student Name: _____ Date: _____

Colour the box of heavy object orange and box of light object pink.

