

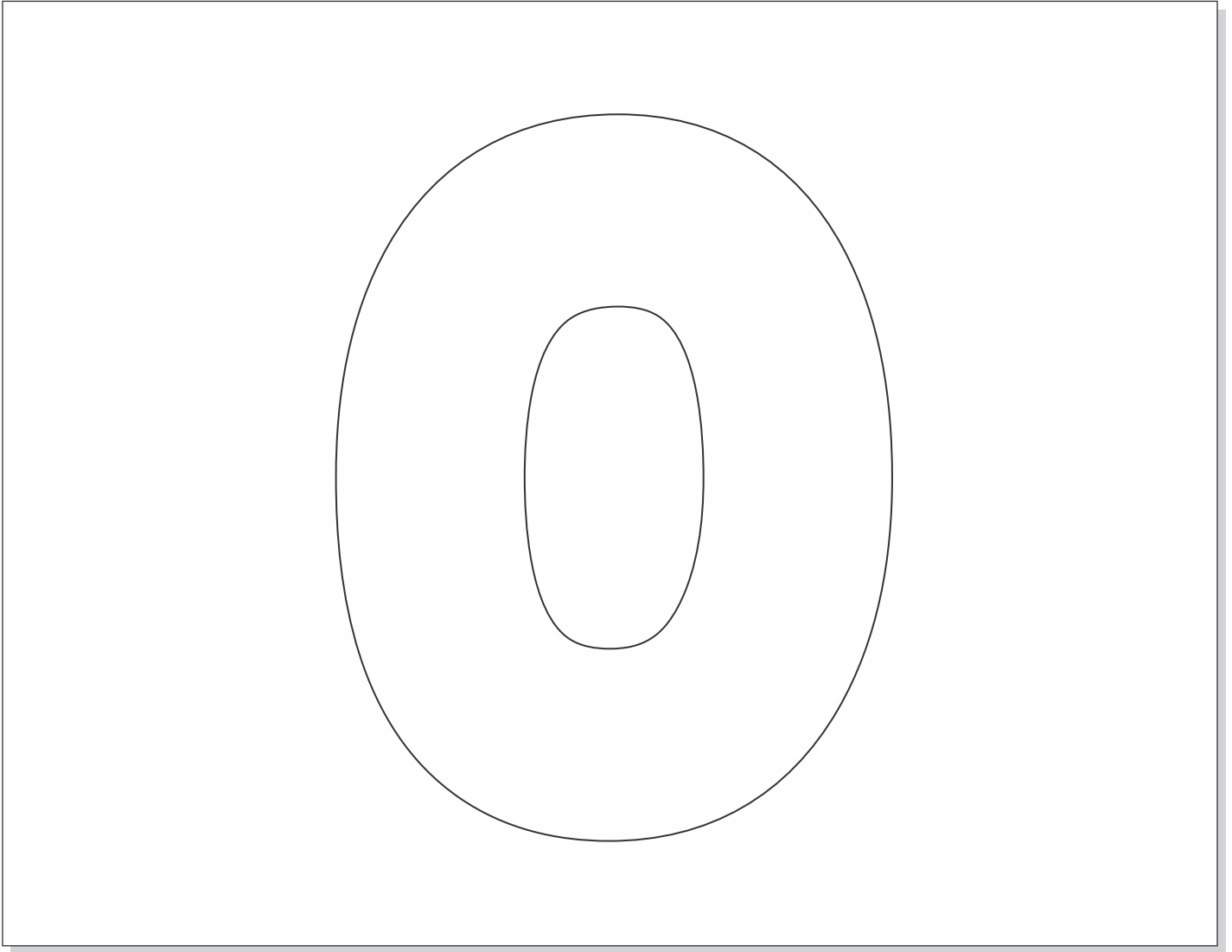

Student Name: _____ Date: _____

Cut the coloured paper into pieces and paste it on number '0'.



Trace number 0:

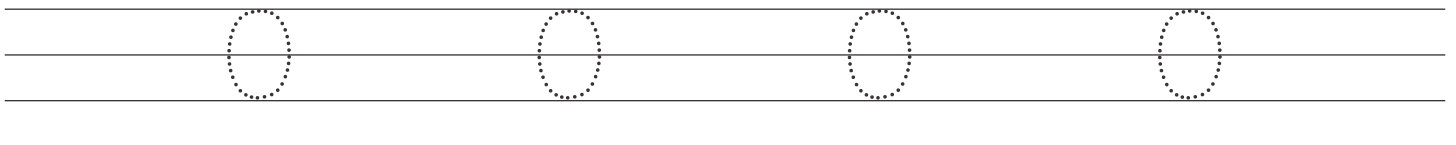



Student Name: _____ Date: _____

Find and colour the number '0'.

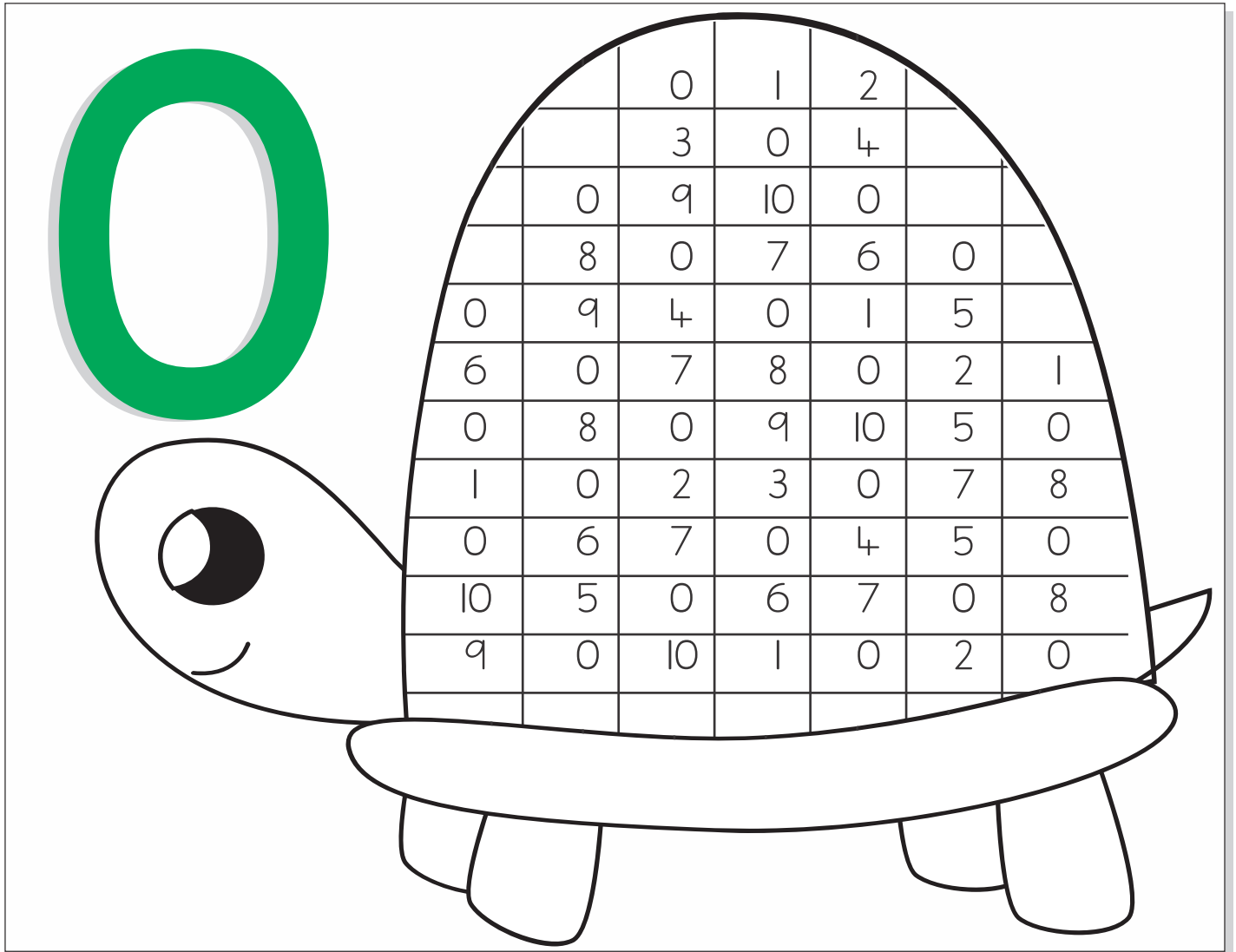

		0	1	2		
		3	0	4		
	0	9	10	0		
	8	0	7	6	0	
0	9	4	0	1	5	
6	0	7	8	0	2	1
0	8	0	9	10	5	0
1	0	2	3	0	7	8
0	6	7	0	4	5	0
10	5	0	6	7	0	8
9	0	10	1	0	2	0

Trace number 0:

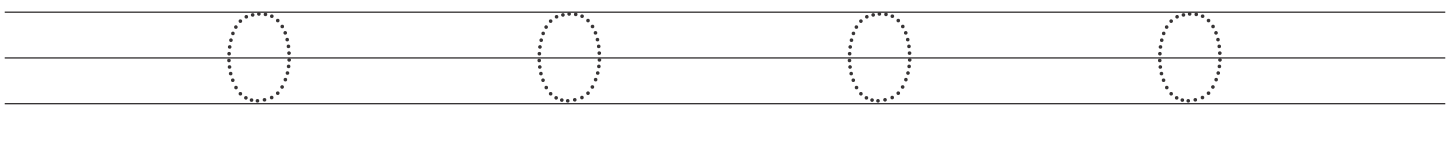



Student Name: _____ Date: _____

Colour the pencil box which has no pencil.

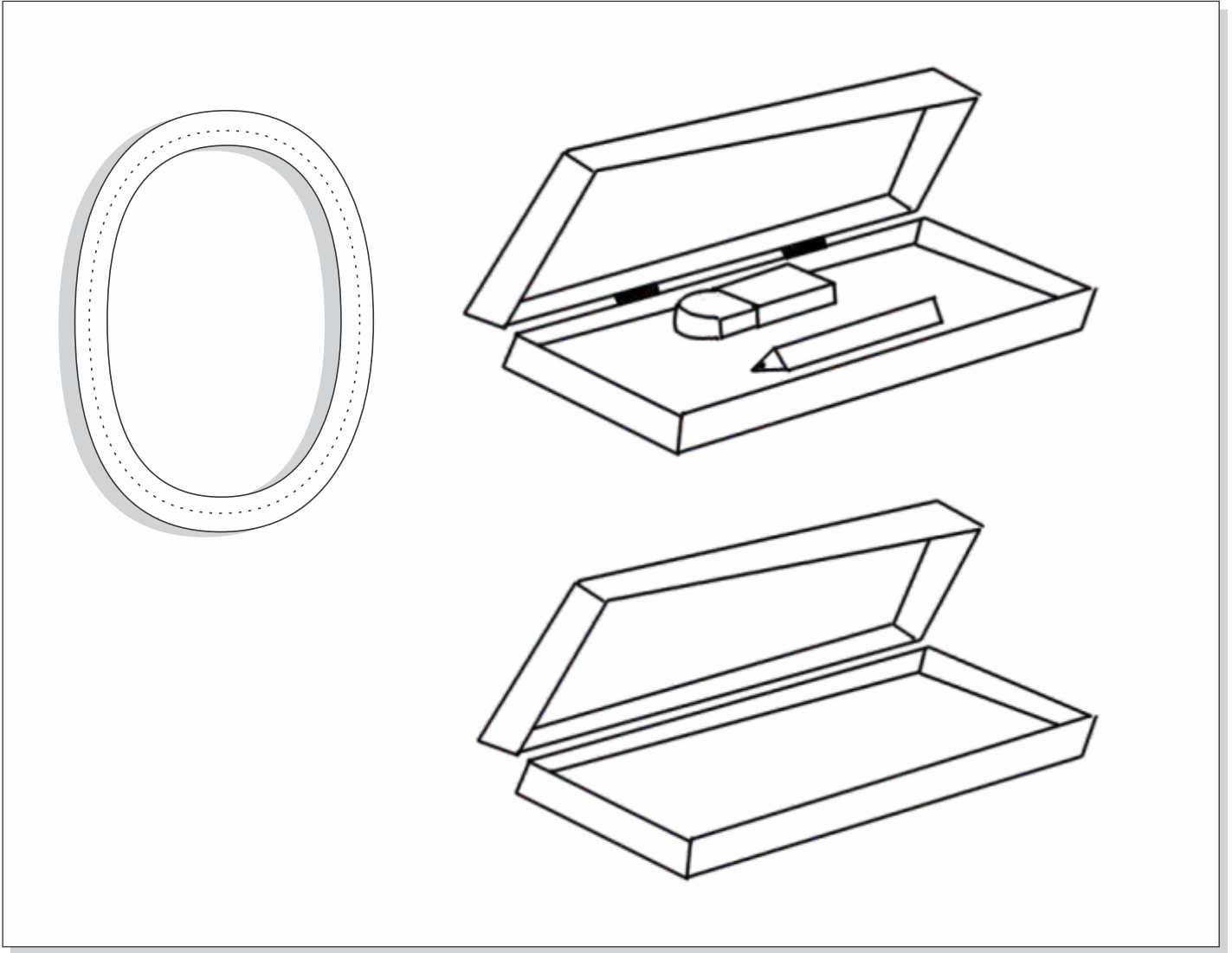

Trace number 0:

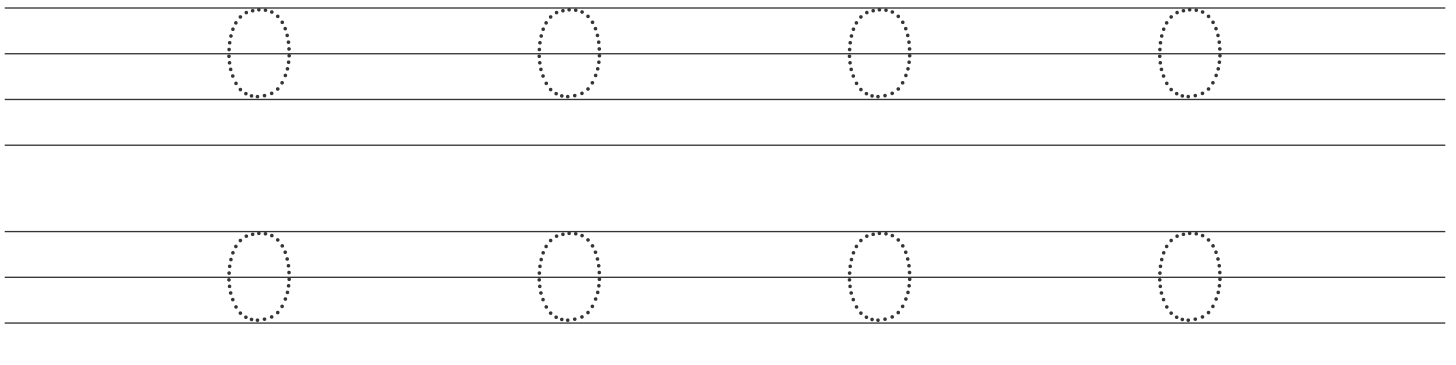



Student Name: _____ Date: _____

Colour the tree which has no apples.

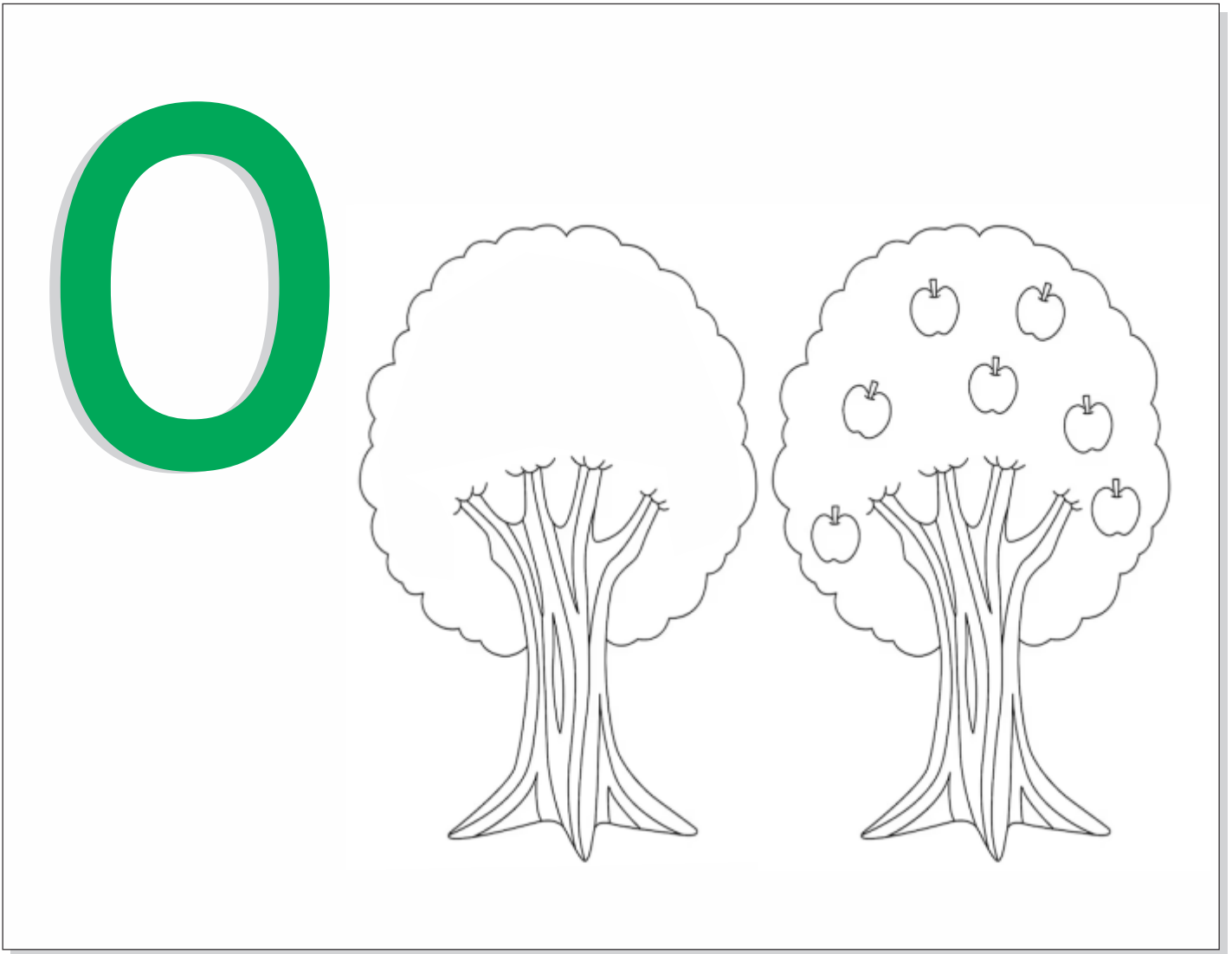

Trace number 0:

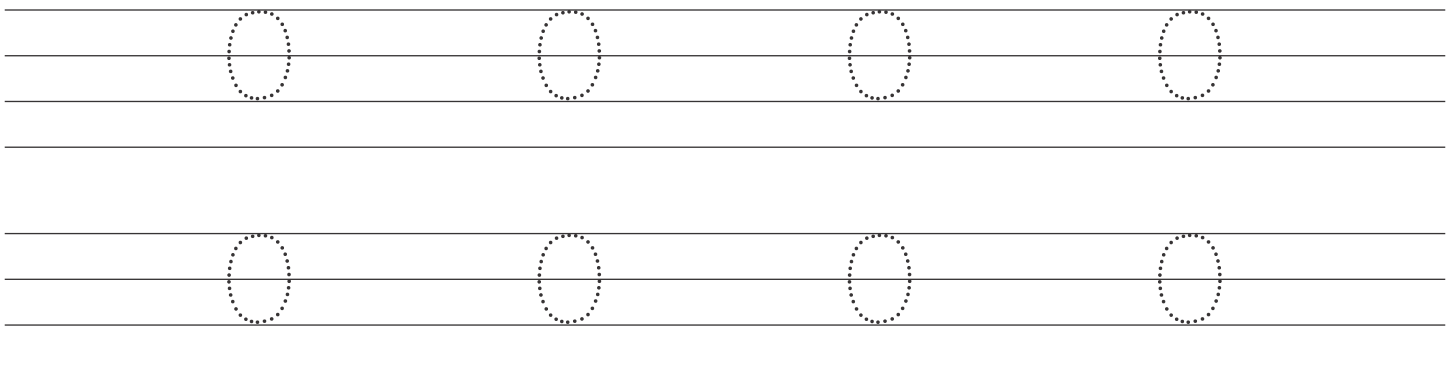



scan QR code for
more worksheets

Student Name: _____ Date: _____

Colour and trace the number '0'.

